

MAL209675222E3

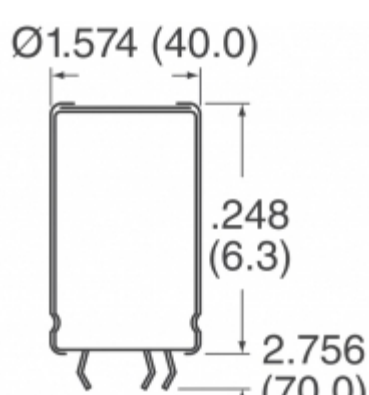

Obrázky jsou pouze orientační.
Podrobné informace o produktu naleznete v části Technické údaje produktu.
Koupit MAL209675222E3 s důvěrou od Component-World.HK, 1 rok záruka



Part Number: MAL209675222E3
Výrobce: Electro-Films (EFI) / Vishay
Popis: CAP ALUM 2200UF 20% 350V SNAP
Datový list: [096 PLL-4TSI \(MAL2096\) Series](#)
[Aluminum Electrolytic Capacitors Guide](#)

RoHS Status: Bez olova / V souladu RoHS
Ship From: Hong Kong
Shipment Way: DHL/Fedex/TNT/UPS/EMS



[Request For Quotation](#)

PARAMETR PRODUKTU

Part Number	MAL209675222E3	Výrobce	Electro-Films (EFI) / Vishay
Popis	CAP ALUM 2200UF 20% 350V SNAP	Stav volného vedení / RoHS	Bez olova / V souladu RoHS
Dostupné množství	3084 pcs	Datový list	096 PLL-4TSI (MAL2096) Series Aluminum Electrolytic Capacitors Guide
Kategorie	Kondenzátory	Napětí - Jmenovitá	350V
Tolerance	±20%	Povrchová montáž Land Velikost	-
Velikost / Rozměry	1.575" Dia (40.00mm)	Série	096 PLL-4TSI
Ripple Current @ Low Frequency	8.2A @ 100Hz	hodnocení	-
Polarizace	Polar	Obal	Tape & Box (TB)
Paket / krabice	Radial, Can - 5 Lead	Provozní teplota	-40°C ~ 85°C
Typ montáže	Through Hole	Úroveň citlivosti na vlhkost (MSL)	1 (Unlimited)
Výrobní standardní doba výroby	13 Weeks	Životnost @ Temp.	5000 Hrs @ 85°C
Rozestup vývodů	0.787" (20.00mm)	Stav volného vedení / RoHS	Lead free / RoHS Compliant
Impedance	34 mOhms	Výška - Sedící (Max)	4.134" (105.00mm)
ESR (Equivalent Resistance Series)	146 mOhm @ 100Hz	Detailní popis	2200µF 350V Aluminum Electrolytic Capacitors Radial, Can - 5 Lead 146 mOhm @ 100Hz 5000 Hrs @ 85°C
kapacitní	2200µF	Aplikace	General Purpose

Component-World.com je spolehlivý distributor elektronických součástek. Specializujeme se na všechny elektronické komponenty řady Electro-Films (EFI) / Vishay. Máme 3084 kusy Electro-Films (EFI) / Vishay MAL209675222E3 na skladě dostupných. Vyžádejte si citát z distributora součástí elektroniky na Component-World.com, náš prodejní tým vás bude kontaktovat do 24 hodin.
RFQ Email: info@Components-World.com

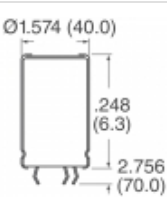
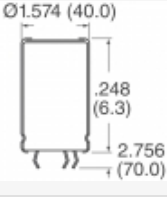
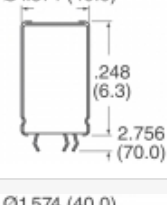
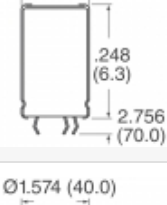
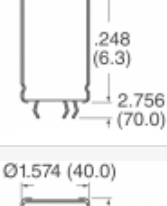
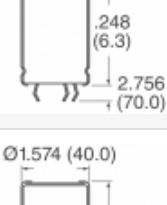
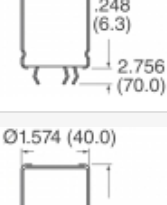
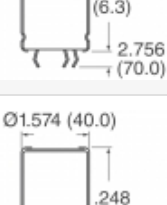
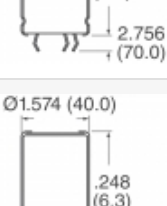
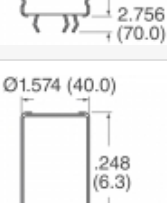
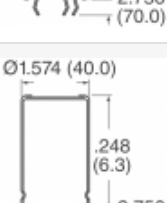
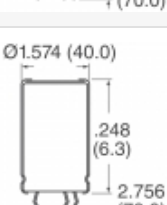
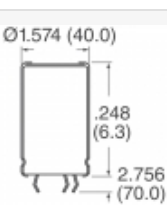
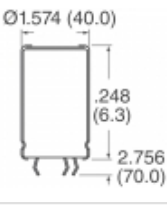
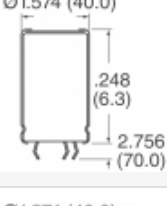
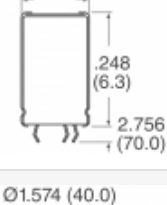
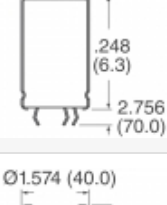
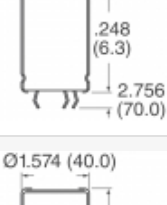
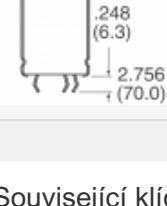
SOUVISEJÍCÍ PRODUKTY

	Část#: MAL209676102E3 Popis: CAP ALUM 1000UF 20% 400V SNAP	Výrobci: Electro-Films (EFI) / Vishay	Dotaz
	Část#: MAL209675182E3 Popis: CAP ALUM 1800UF 20% 350V SNAP	Výrobci: Electro-Films (EFI) / Vishay	Dotaz
	Část#: MAL209674182E3 Popis: CAP ALUM 1800UF 20% 420V SNAP	Výrobci: Electro-Films (EFI) / Vishay	Dotaz
	Část#: MAL209676152E3 Popis: CAP ALUM 1500UF 20% 400V SNAP	Výrobci: Electro-Films (EFI) / Vishay	Dotaz
	Část#: MAL209676821E3 Popis: CAP ALUM 820UF 20% 400V SNAP	Výrobci: Electro-Films (EFI) / Vishay	Dotaz
	Část#: MAL209674102E3 Popis: CAP ALUM 1000UF 20% 420V SNAP	Výrobci: Electro-Films (EFI) / Vishay	Dotaz
	Část#: MAL209674122E3 Popis: CAP ALUM 1200UF 20% 420V SNAP	Výrobci: Electro-Films (EFI) / Vishay	Dotaz
	Část#: MAL209677122E3 Popis: CAP ALUM 1200UF 20% 450V SNAP	Výrobci: Electro-Films (EFI) / Vishay	Dotaz
	Část#: MAL209676122E3 Popis: CAP ALUM 1200UF 20% 400V SNAP	Výrobci: Electro-Films (EFI) / Vishay	Dotaz
	Část#: MAL209674152E3 Popis: CAP ALUM 1500UF 20% 420V SNAP	Výrobci: Electro-Films (EFI) / Vishay	Dotaz
	Část#: MAL209675122E3 Popis: CAP ALUM 1200UF 20% 350V SNAP	Výrobci: Electro-Films (EFI) / Vishay	Dotaz
	Část#: MAL209675102E3 Popis: CAP ALUM 1000UF 20% 350V SNAP	Výrobci: Electro-Films (EFI) / Vishay	Dotaz
	Část#: MAL209677152E3 Popis: CAP ALUM 1500UF 20% 450V SNAP	Výrobci: Electro-Films (EFI) / Vishay	Dotaz
	Část#: MAL209677102E3 Popis: CAP ALUM 1000UF 20% 450V SNAP	Výrobci: Electro-Films (EFI) / Vishay	Dotaz
	Část#: MAL209674681E3 Popis: CAP ALUM 680UF 20% 420V SNAP	Výrobci: Electro-Films (EFI) / Vishay	Dotaz
	Část#: MAL209675152E3 Popis: CAP ALUM 1500UF 20% 350V SNAP	Výrobci: Electro-Films (EFI) / Vishay	Dotaz
	Část#: MAL209675821E3 Popis: CAP ALUM 820UF 20% 350V SNAP	Výrobci: Electro-Films (EFI) / Vishay	Dotaz
	Část#: MAL209676182E3 Popis: CAP ALUM 1800UF 20% 400V SNAP	Výrobci: Electro-Films (EFI) / Vishay	Dotaz
	Část#: MAL209674821E3 Popis: CAP ALUM 820UF 20% 420V SNAP	Výrobci: Electro-Films (EFI) / Vishay	Dotaz
	Část#: MAL209676681E3 Popis: CAP ALUM 680UF 20% 400V SNAP	Výrobci: Electro-Films (EFI) / Vishay	Dotaz

Související klíčová slova pro MAL209675222E3

Electro-Films (EFI) / Vishay MAL209675222E3.	MAL209675222E3 distributor	MAL209675222E3 dodavatel	MAL209675222E3 Cena
MAL209675222E3 Stáhnout datasheet.	MAL209675222E3 Datasheet.	MAL209675222E3 Stock.	koupit MAL209675222E3.
Electro-Films (EFI) / Vishay MAL209675222E3.	Electro-Films (EFI) / Vishay MAL209675222E3.	Vishay Electro-Films MAL209675222E3.	Phoenix Passive Components / Vishay MAL209675222E3.